

# Section 10

- Cables ..... 13, 24-26
- Covers..... 11-12
- Dash ..... 13-21
- Dakota ..... 2
- Gauge Mount ..... 2-6, 11-12
- Lamps ..... 11, 20
- Speedo ..... 2-10
- Speedo Drive ..... 26
- Speedo Sensor ..... 14, 16, 26
- Tank Dividers ..... 21-23

# Dakota Digital

Warranty claims are not done through distributors. All warranty claims are to be done by retail customer directly to Dakota Digital. Policy is repair or replacement only.



## Dakota Digital Bar Mounted Instruments

Available for either electronic or cable driven speedometer applications. Chrome unit features a fully adjustable 255 MPH speedometer, 0-8000 RPM tachometer, odometer and built-in turn signal, high beam indicator, neutral indicator and a low oil pressure warning. Can be mounted directly on handlebar or with a 35 degree triple tree mount. Sending unit or adapter and mount must be ordered separately.

### PCP Description

- 48485 MPH speedo unit (HLY-5000X)
- 48486 KPH speedo unit (HLY-5000X-M)
- 48487 1" to 1-1/4" Bar mount (BKT-5001)
- 48497 1-1/4" Bar mount (BKT-5004)
- 48488 1.5" Bar mount (BKT-5005)
- 48489 Flat riser mount (BKT-5002)
- 48490 35 Degree riser mount (BKT-5003)
- 48491 Adapter for 1996-on electronic trans sender (SEN-5012)
- 48492 Sender for cable drive applications (does not mount to speedo) (SEN-5011)
- 48493 Inductive pick-up sender (SEN-5019)
- 48498 Pick-up sender for cases with no sensor 1996-on



## Dakota Digital Instruments

Vacuum fluorescent instrument system replaces stock Fat Bob style speedometers. These units will work with most single gauge tank mount applications including Road King models (some may require harness modifications). The teal display can be easily read even in direct sunlight. Mounts directly into either the newer stock dash panel or the older dash panel.

### PCP Description

48480\* MPH speedo

48481\* KPH speedo

\*Speedos sold separately, must add applicable sending unit or adaptor listed below.

### PCP Description

48482 Adapter for 1996-on electronic trans sender (SEN-2012)

48483 Sender for cable drive applications (SEN-2011)

48484 Inductive pick-up sender (SEN-2019)

48499 Speed interface for self-cancelling turn signal module



## Dakota Digital Handlebar Mounted Instruments

### PCP Description

48494 MPH speedo

48495 KPH speedo

48496 Tach



## Dakota Digital 1-1/4" Bar Mount 48497

# Gauges



## 80mm Electronic Gauge

Features stainless housing and Y bracket.

### PCP Application

- 48457 1978-on Tach
- 48458 1995-on Speedo



## Mini Gauges

Includes cable and mount clamp and 4 LED indicators on 60mm types only. PCP #48474 and #48475 include LS speedo drive. Features: Blue-Hi Beam, Green-Neutral, Red-Oil and Yellow-Turn Signals.

### White Face

48mm	60mm	Item	Ratio	Year
48474*	48475	Speedo	2:1	1995-99
	48473*	Tach	2:1	Electronic

Note\*: Does not have LED indicators

### White Face Gauges w/3 LED, Black Face Gauges w/4 LED

White	Black	Item	Ratio	Year
48476	48477	Speedo	2:1	1973-94
48478	48479	Speedo	2:1	1995-99

## Billet Gauge Mount

Bracket will accept 48mm gauge and fits on 1-1/4" risor bars.

21875



## 60mm Mini Electronic Speedo and Tach

Features easy push button recalibration and re-settable trip meter, with LED lighting. 8000 RPM Tach has LED lamp. All units have black face and include clamp.

PCP	Item	Ratio	Drive
48440	Speedo	2:1	Mechanical
48441	Speedo	2240:60	Mechanical
48442*	Speedo		Electronic
48470	Tach	0-8000 RPM	
73515	Y Bracket		



Note\*: For use with stock type electronic speed sensor

# Gauges



48554



48556

## Speedometers

PCP	Face/Type	Models
48554	0-120 Mph	1986-91 XL 883 (67016-86A)
48555	0-120 Mph	1985-94 FXR (67020-85A)
48556	0-120 Mph	1983-90 XL (67037-85A)



## Replacement Tachometers

Original style tachometer features an 8000 RPM face. This tachometer will replace the stock tach by wiring the impulse lead to the points side of the coil. See late 78 wiring chart. Chrome rim.

PCP	Years
48552	1985-94 FXR, 1983-87 FXRS, 1983-85 FXRT, 1987-93 FXRS/SP/CON (67042-85)
48553	1985-94 XL (67111-85)
48561	1996-on XL (67042-95)

## Gas Tank Fuel Gauge

FXD 1994-2000

29427 75067-94A



59524

## Multi-Coloured Mini Gauges

60mm Gauge features a 2.4" polished stainless body with a total length of 2.7". Units include a chrome bezel with choice of red, orange, blue, yellow, white, green, purple by the push of a button. Works on a 12 volt system. Tach adaptor required for use with single fire ignition. Speedometer accepts 12mm drive cable.

PCP	Gauge	Ratio
59524	Speedo	2:1
59525	Speedo	2240:60
59526	Tach	Electric



## Electronic Speedo with Black Face (LED)

Mini LED speedo includes handlebar clamp and features a black face with 0 to 140 MPH.

48469 60mm OD 1996-on FXST, 1995-on XL



## 60mm Chrome Tachometer Housing Kit

Kit includes bracket to mount fork stem bolt and a 60mm electric tachometer. Housing, which can be purchased separately, may be fitted with any 60mm gauge.

59875	Tachometer kit
21634	Speedometer kit 1995-on
59876	Housing only
44201	Stem bolt



21634



59876



44201

# Gauges



## 60mm Mini Speedo with LED Indicators to 1995

Speedos feature a white face, 4 indicator lights and a reset knob. Blue indicator light for high beam, green light for neutral, red light for oil, and yellow light for turn signals.

**PCP Application 12mm**

**48467** 2:1 Speedo MPH

**48468** 2:1 Speedo KPH



## 48mm Mini Speedo 1984-95

**PCP Application**

**48471** 2240:60 48mm OD 1984-95 FXST-FLST (white)

**73515** Chrome Y mount all applications

**17039** Light socket with bulb all applications

**5779** 12V bulb all applications (10 pk)



## Tach 1996-on

**48473** 60mm  
0-8000



## 0-160 MPH 60MM Mini Speedo

2240:60 Mini speedo for 1984-95 FXST, FLST models. Black face  
**48472**



## Digital Speedo Tach

Digital gauge includes a bar graph tach, an odometer and trip meter. Gauge also has indicators for oil pressure, neutral, high beam, and turn signals. Half moon shaped gauge measures 110mm L x 57mm H x 38mm D.

**PCP Description**

**21631** Gauge

**27503** Bracket



## Chrome Billet Fork Tube Gauge Bracket

Permits quick and easy installation of mini 48mm gauges to exposed fork tubes. Gauges sold separately.

**PCP Description**

**27504** 39mm

**27505** 41mm



# Gauges



## Mini-Speedo and Tach Kits-MPH

### Custom Speedometer and Tachometer Kits

Complete kits include custom instruments with a resilient rubber mount handlebar clamp and custom cable. Gauges measure 2-5/8" wide x 2-1/16" deep. Permits easy installation on models with stock length forks without any need for additional adapters or modifications.

#### 2:1 Speedo

#### PCP Application

**6629** 60mm Mini 1973-90 XL, 1973-86 FX, 1973-on FXR 0-140 MPH

**48464** 48mm Deco kit, as above, white 1.900" O.D.

**530** Cable for #6629

**21632** 48mm Deco kit 1995-99 XL 0-140 MPH, white

**21633** 60mm Mini kit 1995-99 XL 0-140 MPH, black face

Note: 6629 Can be used on 91-95 if self cancelling is forfeited

#### Tach Only

**739** Electric 3-wire type

**48466** As above, black 1.900" O.D.

**48508** As above, white 2.400" O.D.

Note: To use **739** on 1978-on models with coil triggered tach, the Green Negative wire goes to ignition side of coil. Red wire goes to breaker side, Tach head must be grounded by black wire.

Cable **530** fits kit **6629**.

### Custom Mini Speedo & Tach Gauges

Show-chrome speedometer and tachometer gauges feature strong chrome steel mounts, rubber mount handlebar clamps, accurate non-fluctuating indicators, 12-volt dial light compact size (2 3/8" x 2 1/16"). Waterproof construction and vibration resistant. **Cable not included**

#### Speedometers

**738** (2:1 ratio) can be used on XL models 1973-90, FX models 1973-90, and FXR models 1982-90 when connected to front wheel speedometer drives. MPH Face.

**530** Standard cable 39"

**528** + 4" cable

**529** + 8" cable

#### Tachometers

**741** 2:1 ratio fits all models with mechanical tach drives

**2539** Tach cable XL 1974-80

**739** Electric tachometer for 1978-on models w/coil triggered tach

**16501** Replacement handlebar gauge clamp

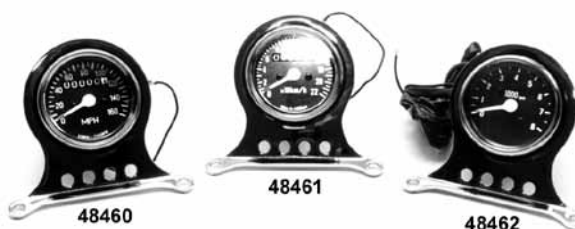

### Chrome Rubber Mount Clamp

Clamp is used to attach gauges or mirror to frame or handlebar to reduce vibration. Fits 1" bar.

**16501**



### 2.850" O.D. Mini Gauge Kit

Kits include gauge, chrome mounting bracket (no visor), chrome gauge cup, rubber grommet and hardware. Fits most BT and XL 1973-on.

#### PCP Description

**48459** 2:1 MPH Speedo

**48460** 2240:60 MPH Speedo

**48461** 2:1 KPH Speedo

**48462** Tachometer, coil driven

#### Tech Tip

Black = ground

Red = (+) coil

Green = (-) coil

Blue = light



### Chrome Billet Speedo Tach Assembly

Clamps to 1" or 1-1/4" bars and includes speed, RPM and temperature functions.

**21876**



### Chrome Billet Housing

Will accept 48mm electronic tachometer or speedometer.

**59735**

# Speedometers

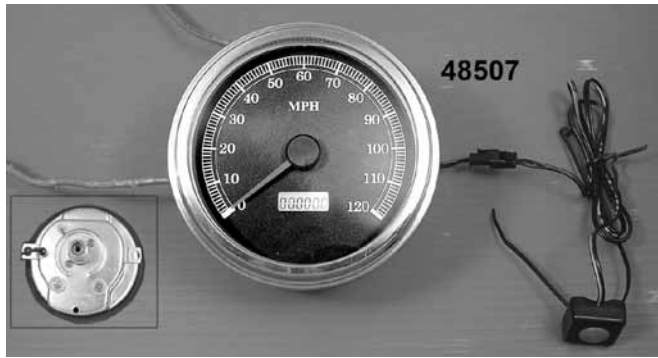

48507



48509



48535

## MPH Multi-Ratio Speedo

Programmable for 1:1, 2:1 or 2240:1 ratio applications. MPH speedo features an LED odometer readout and will accept 12mm or 16mm (5/8") cable ends.

### PCP Description

- 48507 Speedo
- 48509 Speedo with tachometer
- 48535 Speedo with tachometer (digital)



48566



48567



28517

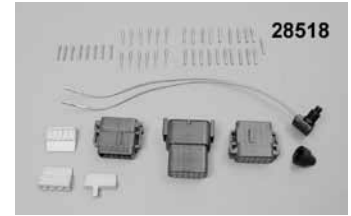

28518

## Electronic Speedo for FXST, FXWG 1996-on

- | PCP    | Description  |
|--------|--|
| 48566  | 1996-98 (67027-96C)  |
| 48567* | 1999-03 (67033-99)   |
| 28517  | 2000-on Speedo sensor harness for use with speedos equipped with an electronic speed sensor (68820-98) |

28518 1996-98 Harness (67418-99)

\*Note: Can also be used to update 1996-98 models but requires separate purchase of wiring harness #17288



17288



17290



17291

## Speedo Reset Knob

Fits 1998-on models. Replaces 67854-98.

- | PCP   | Item            | Model        |
|-------|-----------------|--------------|
| 17288 | Harness         | 1995-98 FXST |
| 17289 | Harness         | 1995-98 FL   |
| 17290 | Reset knob      | All          |
| 17291 | Reset knob boot | All          |

# Speedometers



## Speedos 1989-on Face

- 48505 BT w/graphic face 1:1 trans
- 48513 2240:60 MPH police speedo



## KPH Speedometers

They are offered in a variety of face styles and feature trip meters. All speedometers accept 5/8-18 threaded cables, (late model front wheel drive cables will not fit, #2538 custom cable will adapt these gauges to those models). When used with early tin dashes our #48000 antique reset knob must be used. For diecast dashes use our #3720 (1968-84 style), 1989-on FXST knob will not fit these speedometers.

### 2:1 Ratio Speedometers (1400RPM=60KPH)

Fits FXWG 1984-86, and Softails 1984-95 with front wheel drive units.

- 48516 1936-40 white face with black numbers
- 48524 1962-67 black face with 'zinc' coloured numbers
- 48526 1968-84 black face with white numbers
- 48527 1985-on new style, black face with white numbers
- 48532 1991-95

**NOTE: 1991-on turn signals will not self cancel**

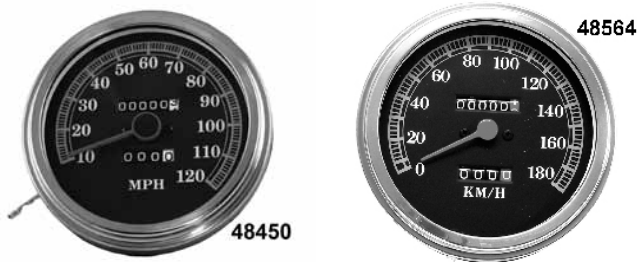

## FXST Speedo With Switch 1991-99

Speedos with a self cancelling turn signal switch are available in 3 face designs. Fits FXST-FLST using a 12mm cable drive. 2240 RPM = 60 MPH ratio.

- 48450 1985-on Face design 2240:60 MPH (67027-91A)
- 48564 1991-95 2240:60 KPH (67030-81D)
- 29727 1996-99 Electronic MPH (no reed switch) (67027-96C)

## Choosing the Right Speedo Ratio



Fits 4 speed FL and FX models with transmission driven speedometers 1968-83.



Fits FL models with transmission driven speedometers 1947-67, and Sportster, FX and FXR with front wheel speedometer drives 1973-90 (except Softail and 4 speed FXWG). May also be installed on Sportster, FXR, Dyna Glide with front wheel drive speedometers 1991-94 if the self-cancelling turn signal feature is forfeited.



Fits all Softail and 4 speed FXWG 1984-90 and 4 speed FL with front wheel speedometer drives 1981-84. May also be installed on models 1991-95 if the self-cancelling turn signal feature is forfeited.



## Digital Speedo Assembly

- PCP Application**
- 48568 1996-98 ST (requires speedo harness #17288)  
Will not fit 1999 ST  
1995-03 FLHR  
2000-03 ST  
1995-03 FXDWG
  - 48569 As above, with digital LED
  - 48570 2004-06 FXDWG, ST, FLHR
  - 48571 2004-07 ST, FLHR



## FLHR Speedo Reset Knob 1998-on

- 17418 67854-98

# Speedometers



48423



48413



48429



48417



48434



48414



48431



48418



48421



48401



48419

## MPH Speedometers, Big Twin Dash 1968-on

Offered in 1:1 and 2:1 ratios with the newer style re-set knob (for cast dashes). Available with a 5/8-18 thread for transmission drive unit, or for front wheel drive. Rubber isolation ring and mount kit included.



## Electronic MPH Speedo FXST 1996-99

- 29727 Speedo
- 73702 Dash panel mount bracket 1996-98
- 73705 Dash lense 1996-on

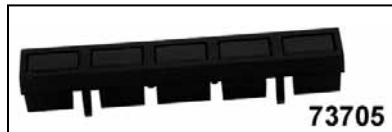

73705



73702

## 2:1 Ratio Speedometers (2000RPM=60MPH)

Fits FXWG 1984-86, and Softails with front wheel drive units. (12mm speedometers use stock front cable)

- 48401 1936-40, off white face with black numbers
- 48413 1948-61, green & black face with silver numbers
- 48414 1948-61, as above but with 12mm threads for FWD
- 48417 1962-67, black with 'silver color' numbers & center
- 48418 1962-67, as above but with 12mm threads for FWD
- 48419 1962-67, as above but 2240rpm=60mph
- 48421 1968-84, black face with numbers
- 48423 1968-84, as above FWD with 2240RPM speedo for FXST=60MPH
- 48434 1985-95, black face with white numbers and 12mm threads for FWD
- 48429 'Police' 120MPH, black face with white numbers
- 48431 'Police' as above, 12mm / FWD & 2240rpm=60mph

### Note:

- FWD fits stock cable, 5/8"x18 thread require #2538 cable.
- 2:1 ratio speedometers may be installed on 1991-99 models if the self-cancelling turn signal feature is forfeited.

## SPEEDOMETER RATIO GUIDE

TRANSMISSION DRIVE		FRONT WHEEL
FL 1941-E61	11 Tooth 2-1 Ratio	FX 1973-79 & 81 On 2-1 Ratio
FL L1961	13 Tooth 2-1 Ratio	FX 1980 1:1 Ratio
FL 1962-68	13 Tooth 2-1 Ratio	FL 1981-84 2240:60 Ratio
FL 1969-80	23 Tooth 1-1 Ratio	FXST & FXWG 2240:60 Ratio
FX 1971-79 & 1981	23 Tooth 1-1 Ratio	

# Speedometer Hardware

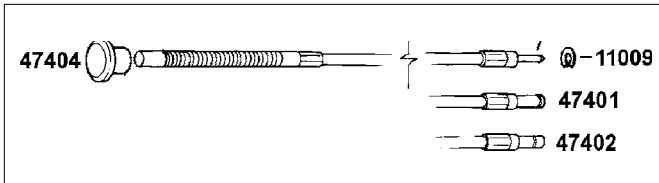

## FLH Choke Cable

Complete assemblies include chrome knob casing and inner wire, for dash mounting.

PCP	Item
47401	Assembly 1979-84 FLH (29213-79)
47402	Assembly 1986-89 Softail (29211-86)
47404	Chrome knob FL 1982-89 (29214-71)
23022	Rubber grommet 1982-on (27451-82) (5 pack)
11009	Retaining ring 1979-on (11013) (10 pk)

## Choke Knob

Dash mounted cable nut kit fits FXWG 1980-86 and FXST 1984-on (27452-82). Zinc finish.

48009

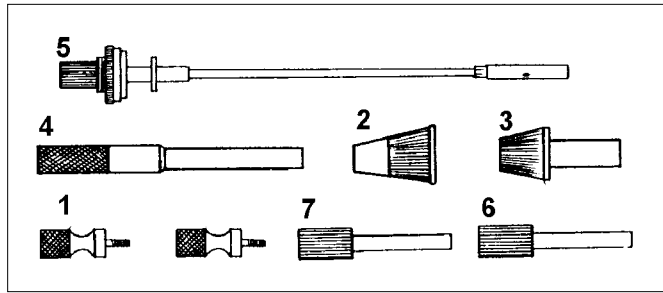
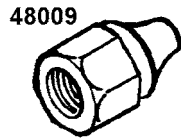

## Odometer Reset Knobs

#	PCP	Description
1	48000*	Knurled 1968-84 (5 pack)
1	48003*	Knurled FL-FXST 1981-95 (each)
2	48001	FLH 1968-84 (67215-68) (5 pack)
	3720	1968-84 FL (67215-68) (each)
	24553	Screw for above (67217-68) (10 pack)
3	48002	FXST 1981-95 (67215-89) (5 pack)
	24540	Screw for above (67117-85) (10 pack)
4	48004	All female (each)
5	1341	Chrome FXE 1973-84 (67210-73)
6	48005	Chrome FXR 1985-94, Dyna Glide 1991-93 (67122-85) (each)
7	48006	Chr. XL 1985-94, FXLR 87-94 (67108-83) (ea)

\*Note: Knurled type fits most aftermarket FL gauges



## Big Twin 'ISO-Support'

Is a molded rubber support to increase speedometer rigidity and reduce vibration for FL, FXST, & FLST models. Recommended used with our speedometer-iso mount pin kit 4249.

PCP	Fits
23011	Rubber support 1968-91 (67115-91)(each) (shown mounted on speedo)
4249	Kit to mount speedo with 3/8" holes (67066-76)



## Revolution Speedometers

PCP	Application
29724	1984-89 FXWG, 1986-90 Softail (KPH) (67288-93T)
29723	1984-86 FXWG, 1984-90 Softail w/out reed switch MPH (67027-93T)

Connect Red to ignition switch side, Green to breaker side of coil. Speedo-tach head must be grounded



## 2:1 FL Speedo with Tach

The 2:1 ratio unit is designed to work with OEM transmission speedometer drive units on 1947-67 FL's, as well as late model front wheel speedometer drive applications (OEM drive 67127-73, #2533 OEM 67073-81, #2547. When used in front wheel drive applications, use our custom speedo cable #2538

1315	1984-85 FXWG; 1984-90 FXST front wheel drive uses custom cable
------	--

# Brackets & Covers

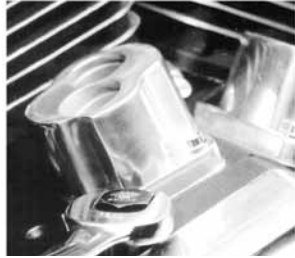

## Chrome Speedo & Tach Brackets

Fit FXR and all XL models. 23009 is the flexible black rubber visor. 1452 includes visor.

PCP	Lite	Application
2233	3	1983-85 Single (67053-83T)
1452	4	1986-91 Single (67053-86)
45451	Slot	1992-on Single (67083-92)
21833		1995-05 Single (67293-95)
2222	3	1984-91 Dual (67110-83T)
1450	4	1986-91 Dual (67036-86)
45452	Slot	1992-94 Dual (67167-92)
17287		Indicator lamp bezel for above
45306		1995-05 Dual (67294-95A)
23009		1984-91 Rubber (67039-83)

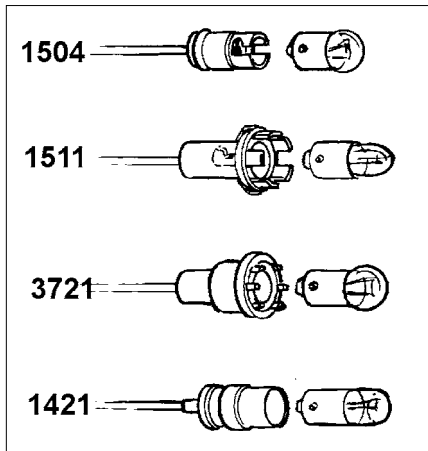

## Speedo/Tach Lamp Sockets

Speedo	Application	Body	Bulb
1421	FX (67327-78)		
1511	FL 1948-85 (71151-48)	Metal	Yes
3721	BT 1948-on (71151-70)	Plastic	Yes
62006	FXST 1986-95 (71158-86B)	Metal	No
62009	FXST 1996-on (67191-94)	Metal	No
62008	FXST 1995-98 (67184-94)	(vinyl wire)	
Tach			
1504	71151-67B		

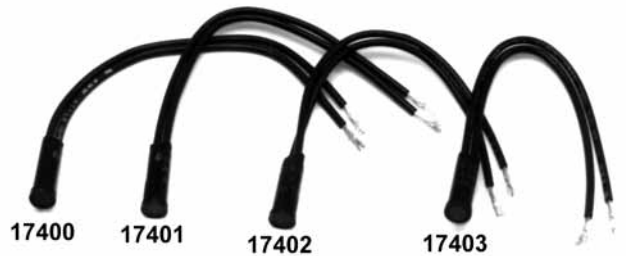

## Indicator Lamps

These indicator lamps fit most models from 1986-on and are available in four different colours. They're shipped with 6"-long leads that are not connected but include Original Equipment-style terminals. Sold Each.

PCP	Colour
17400	Red Oil (68022-92A)
17401	Amber (67864-86)
17402	Green Neutral (68574-86)
17403	Blue (68023-92A)
17406	Green Turn (68021-92A)

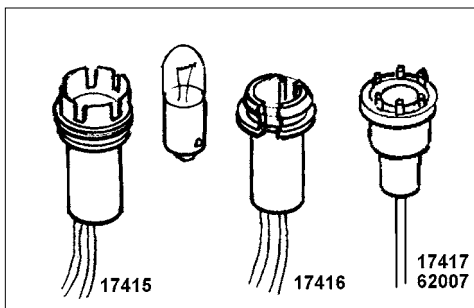

## Dash Light Sockets

PCP	Body	Wires	Bulb	Application
17415	Steel	2	Yes	Ground wire to body (3 pk)
17416	Plastic	2	No	(3 pack)
17417	Metal	1	Yes	(3 pack)
17409	Insulated	2	Yes	(pair)
62007	Metal	1	No	FXST (71162-70) (each)



## Indicator Decal

22163 3 Hole decal, "beam/ neutral/oil" (68464-86) (5 pk)

# Brackets & Covers



## FXR Chrome Gauge Covers

PCP	Years	Item
45346	1984-90	Speedo and tach set
63029	1984-94	Tach (67092-85)
4520	1984-90	Speedo bottom (67090-85) (each)
45450	1991-94	Speedo (67091-91) (each)
45329	1983-90	Lower speedo (67103-83)
23077	1983-on	Rubber cushion (92061-83)
23085	1984-91 XL 1987-on FXLR	Rubber cushion (67104-83)
23086	1992-on XL	Rubber cushion (67121-92)



## Chrome Speedo/Tach Trim

Attractive chrome trim installs over gauge bezel to fill the space between the gauge and mounting bracket or dash. Installs with silicone adhesive. Sold each.

**55113** Fits speedo and tach on FX, FXR, FXD, XL 1983-95 (3-5/8" O.D.)



## T/L Chrome Gauge Bezel

Use the chrome gauge bezel to add style and polish to the look of your instruments. Fits 2000-on speedo and tach gauges on XL, Dyna (not FXDWG), FLHT and FLTR models.

**63025** 74541-00 (each)

# Big Twin Dash

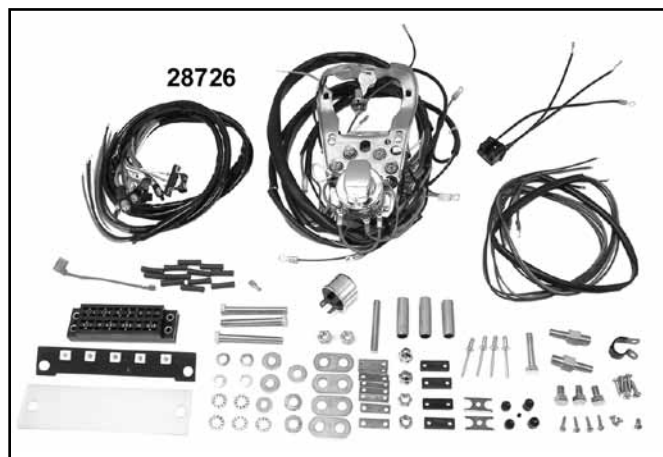
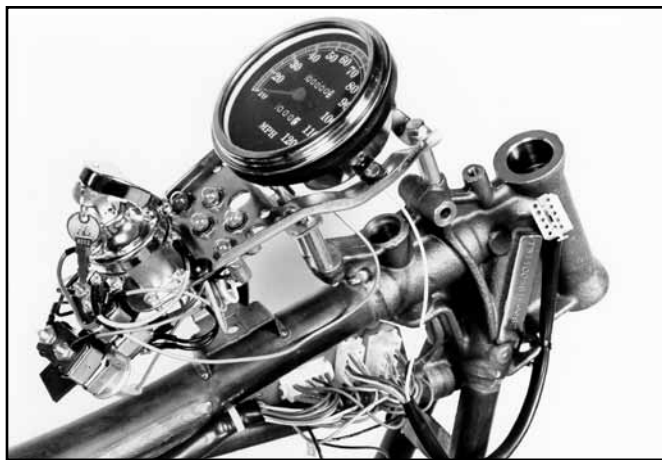

## Wire Harness/ Dash Base Assemblies

PCP	Type	Application
28728	5 Light	FXST, FLST 1987-88 (6 post key switch)
28729	5 Light	FXST, FLST 1989-90 (6 post key switch)
28727	5 Light	FXST, FLST 1991-95 (6 post key switch)

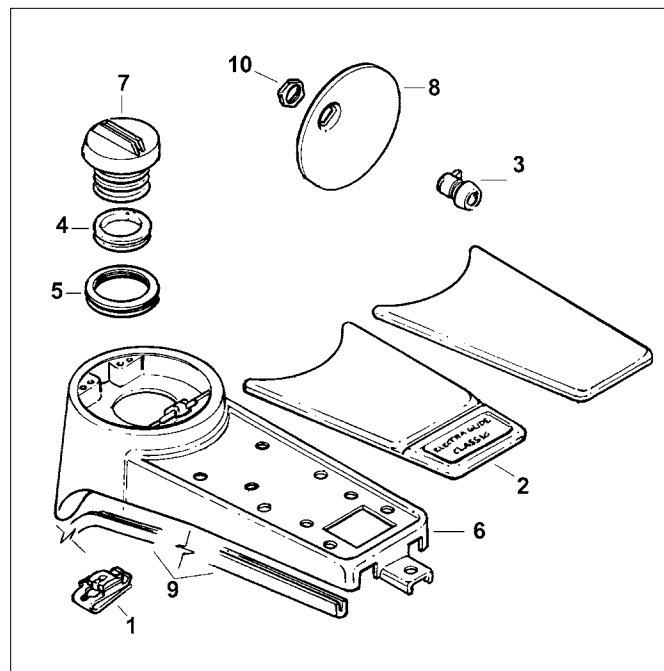

## FLT Fuel Tank Console 1988-on

#	PCP	Description
1	12626	Clip nut (7743A) (each)
2	29101	Panel insert, black (60957-89A)
	29103	Panel insert, black (60973-90)
3	62022	Lock (no keys) (61029-92A)
4	79435	Filler cap gasket (61109-85C) (10pk)
5	23048	Boot, filler tube (61112-82A)
6	64802	Console 1988-97 (61282-03)
	64803	Console 1998-on (61270-98)
7	29104	Filler cap, vacuum vent (61274-92)
8	29105	Console door (61278-92)
9	23047	Rubber molding (71294-89)
10	12627	Lock nut (84850-92) (5 pk)



## Rear Wheel Speedo Kit 1986-99

Fits FXST-FLST models. Use on applications when front wheel drive unit cannot be installed.

27222

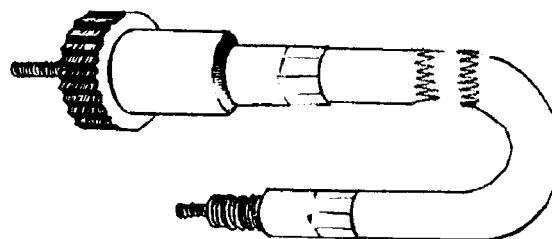

## Custom Front Wheel Speedo Cables

Front wheel drive speedometer cables that allow you to use any of our large FL style dash mounted 2:1 speedometers for front wheel speed drives. Cable has two speedo head nuts to cover most models. Also replaces the stock cable on 1984 FXWG or FXST The ideal cable for installation with our FXR FatBob tank 6478.

2538	40" long
47419	As above, stainless
4391	43" long
47424	As above, stainless
47422	47" long



## Cable Adapter

Allows the use of a 5/8" cable on 12mm FX & XL threaded speedos.

12631 Each

# Big Twin Dash

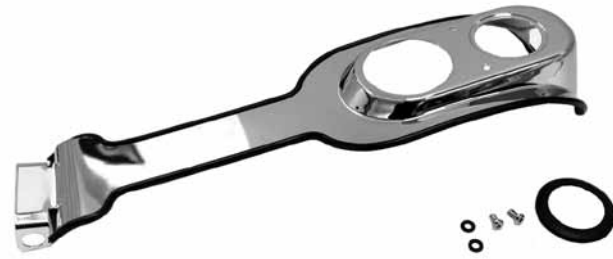

## T/L Chrome Dash Trim Panel

Panel fits 1995-03 FXD Super Glide, 2001-03 FXDXT, 1999-03 FXDX and 1994-00 FXDS-Conv models.

**64830** 67221-97



## Chrome LED Dash Panel Assembly

Features switch and LED indicator lamps

**PCP Application**

**45923** 1968-99 FL-FLST

**45924** 2000-on FXST



## Chrome Dash Panel Extension FXST 2000-on

This panel extends the look of the dash on 2000-on Softail models except FXSTD.

**59261** Fits FXCW/C, FLSTSB, 2009 FLSTC, FLSTFSE2, FXSTSSE/2 (71283-01)



## Programmable Transmission Speedometer Sensor

Is a fully adjustable sensor assembly for all 5&6 speed transmissions with electronic drive speedometer. Allows fast and accurate adjustments for any tire size, pulley on gear ratio change.

**28299**

# Big Twin Dash



**Bobbed Dash Component Kit FXST 1996-99**  
 Chrome dash panel assembly fits FXST 1996-99.  
**45921**



**Chrome Dash Cover FXDWG 1997-on**  
 Chrome, full length dash panel uses the existing speedo, indicator lamps and wiring. Some seats may cause interference.  
**45913** 2004-on FXDL (67187-04)

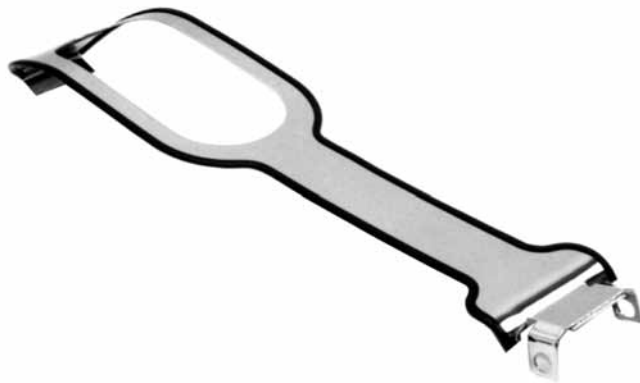

**Chrome FXDL Dash Panel 1991-03**  
**45425** 61655-91

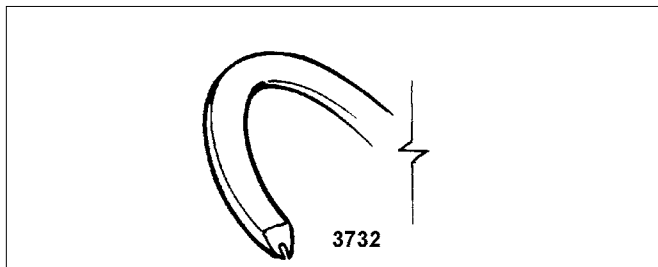

**Dash Board Rubber Strip**  
 Closes the gap between dash and tanks. Helps prevent dash from wearing paint off tank and also reduces vibration. Black except where noted.

- | PCP          | Fits                         |
|--------------|------------------------------|
| <b>23100</b> | 27" Chrome edge trim         |
| <b>3732</b>  | FL dash 1968-on (71295-68)   |
| <b>651</b>   | FXS dash 1977-on             |
| <b>23074</b> | FXST dash 1995-on            |
| <b>23075</b> | FLHR dash 1999-on (71001-94) |
| <b>23076</b> | FXDL dash 1995-on (67119-95) |



**Chrome Dash Panel**  
 Extends the look of the dash on 2000-on FXST models. Does not fit FXSTD or SE's.  
**64255** Fits FXCW/C, FLSTSB, 2009 FLSTC, FLSTFSE2, FXSTSSE/2 (71283-01)

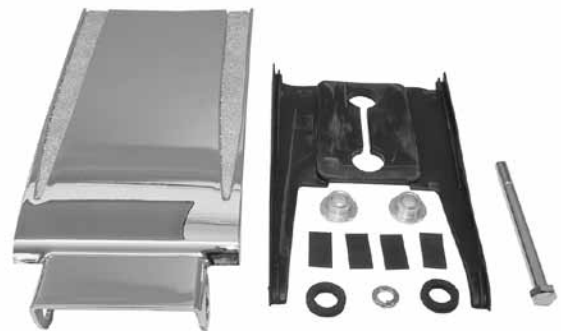

**Chrome Dash Panel Extension for FXDWG**  
**64256** 1995-03 FXDWG (71284-01)  
**64286** 2004-07 FXDWG

# Big Twin Dash



64803



64827

## Chrome Dash Panels for FXDWG

PCP	Application
64827	2000-04 (71246-99)
64835	2005-on (71211-04)

## Chrome Dash Panels

PCP	Description
64825	Cast 1999-on FLHR (60960-99)
64803	Cast 1998-on FLHT (61270-98)
9940	Allen mount kit for #64803



29513

## T/L Electronic Speedo Sensor FLT 1997-03

29513 74429-97C



## Chrome Speedo Sensor Block-off Plate Kit

Kit includes plate, gasket and mounting screw for 1996-on FXST models.

73512



## Electronic Speedo Transmission Sensor

Sending unit fits stock BT 5 speed.

29500	Softail 1996-99 (74437-96)
29501	All Softail 2000-06 and FLT 2004-06 (74430-00D)
29510	FLT 1995-96, Dyna 1994-05 (74420-94C)
29513	FLT 1997-03 (74429-97C)
29504	XL 1995-03 (74402-95B)
29538	XL 2004-on, Touring 2007-on, Softail 2007-on, Dyna 2006-on (74402-05)

## Allen Bolt Custom Cap Covers

These cap covers are sized by bolt thread diameter. Chrome plated and machined from aluminum, these caps come with set screws and an allen wrench. Sold in pairs.

45310	1/4"
45311	5/16"
45312	3/8"

# Big Twin Dash



## Late FLH Dash Kit

Includes cast type dash, speedo, switch, choke mount and knob, hardware and rubber strips. Stock on 1968-84 FL-FLH. Can be adapted to all 3-1/2 & 5 gal. tanks 1948-84 features dash base with wirings and sockets. Complete dash kit available as:

- 6300** 1:1 Ratio
- 6301** 2:1 Ratio
- 90151** 2240:60 Ratio

## Diecast FL Dash Hardware Kit

Includes all parts pictured to fit the FLH-FXWG-FXST 1975-95 cast type dash.  
**786** Hardware Kit

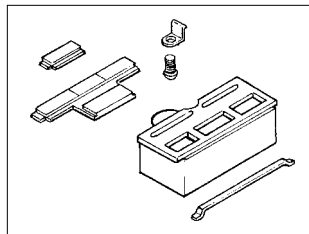

## Dash Panel Decal

Replaces OEM 71300-79 on all FL, FLH, FXWG models 1979-93. Black matte finish with adhesive backing.

- 5193** Sold Each

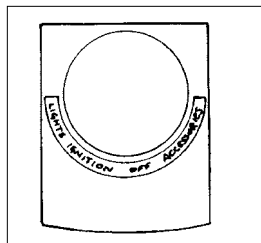

## Dash Base Assembly 1986-95

Includes wired base 6 post switch, switch harness, 3 circuit breaker and flasher. Allows use of either the turn signal canceller PCP# 17225 (not included) or flasher #28004. Assembly ready to accept plug in harness (not included).

- | PCP          | Description             |
|--------------|-------------------------|
| <b>48602</b> | Dash base assembly      |
| <b>28689</b> | Builder harness 1987-88 |
| <b>28690</b> | Builder harness 1989-90 |
| <b>28691</b> | Builder harness 1991-95 |



## Late Style Cast Dash

This heavy-duty zinc die cast dash is a beautifully chrome plated duplicate of the OEM part. Complete in every detail, the kit also includes the lenses, light divider and trim rubbers. Can be used on most 4-speed frames and Softails when the correct dash base is used.

- | PCP          | Description   |
|--------------|---|
| <b>2925</b>  | FL 1968-84, FXWG 1980-86, FXST/S and FLST/F 1984-90 (71241-68B) |
| <b>45920</b> | 1991-95 (not FXDWG). For self-cancelling signals (71241-91)     |
| <b>45922</b> | FXST 2000-07 (not FXSTB) (71250-00)                             |
| <b>3732</b>  | Trim rubbers (71295-68) (pair)                                  |



## Late-Style Cast Dash Mounting Plate

A complete mounting kit for all Big Twins 1968-90 with cast-style dashes. Includes all the hardware necessary to fit both the standard early-style Fat Bob tanks and the later-style flatside Fat Bob tanks. Includes all parts pictured. Everything necessary for easy installation.

- 48600** Fits #2925 dash kit or FL, FLST 1968-90 (not Dyna WG)
- 4397** Replacement dash light socket (each)



## FXST Dash Mounting Hardware

This kit includes bolts, spacers and hardware necessary to install dash base on 1984-98 FXST & FLST models.

- 48601** Kit

# Big Twin Dash



## Chrome Long Rider Dash Panel

This panel is designed for "Bob" tanks on FLH-FXST-FXWG models, 1968-95. Rubber strip included.  
**45430**

## Long Rider Complete Dash Kit

With speedo and switch for 1948-95 BT.

PCP	Ratio
90267	2:1
90268	2240:1



## Chrome Dash Kit for Fat Bobs (less Speedo's)

Complete kits feature: chrome dash cover, base plate assembly, ignition switch and mounting hardware.

- 91200** Cateye
- 91201** 2-Light
- 91202** 3-Light

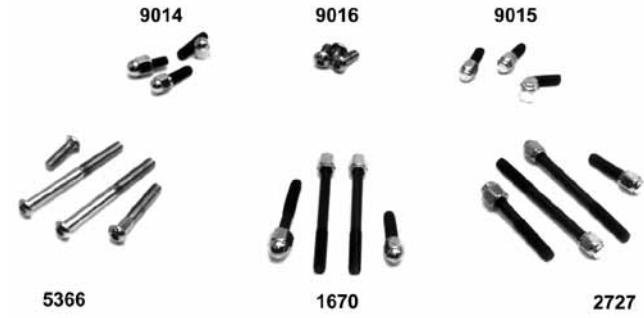

## Dash Mounting Kit

Complete 4-piece set of chrome plated, button head, socket style dash panel screws for all Low Rider and FX tank mounted guage covers. Acorn or cap.

- 1670** Acorn 1978-85 FX
- 2727** Cap 1978-85 FX
- 9014** Acorn 1986-94 FXR models (except FXRS 1988-on)
- 9015** Cap as above
- 9016** Button as above
- 5366** 1977-85 FX (4 pack)

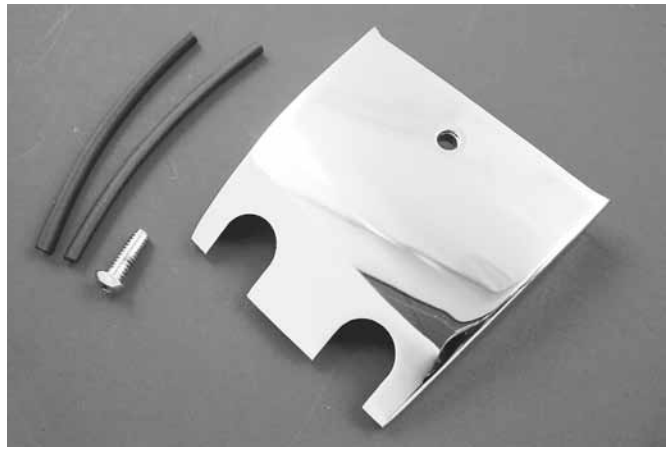

## FLHR Chrome Tank Panel 1989-07

For use with shorter seats.

**45845**



## FXDL Speedo and Tach Cover

Chrome speedo and tach instrument cover fits FXDL 1995-03.  
**29636** 67189-95



## 3/16" Chrome Harley Speedometer Trim

Fits on Harley speedo housing and comes with krommets, studs, washers and nuts.

**408**

# Big Twin Dash



## 2 Light Fat Bob Speedo Kits

Complete kit allows for a trouble-free installation when converting to Fat Bob tanks. Kit includes 2-light dash cover, 120 mph speedometer, dash base plate (with wiring, sockets and hardware) and ignition switch.

**2:1 Ratio**

**6305** 1973-90 FX, FXR with front speedo

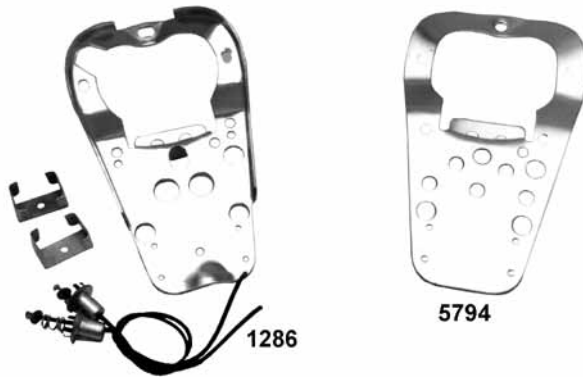

## Dash Mounting Plates

2 Light dash mounting plate includes wiring and sockets. Basic mounting plate # 5794 is for use with Fat Bob dash covers 1283 and 1282 when dash lighting is not desired.

**1286** 2-light dash mounting plate with circuit breaker clips: fits PCP dash 1283

**5794** Base only (without dash lights)



## Dash Base/Hardware

- 66132** Dash base Softail 1991-on (70936-91B)
- 62005** Fuel gauge lamp socket FXR 1982-94 (69540-78)
- 62006** Speedo lamp socket Softail 1986-95 (71158-86B)
- 62007** Metal dash socket 1 wire BT 1970-on (71162-70)

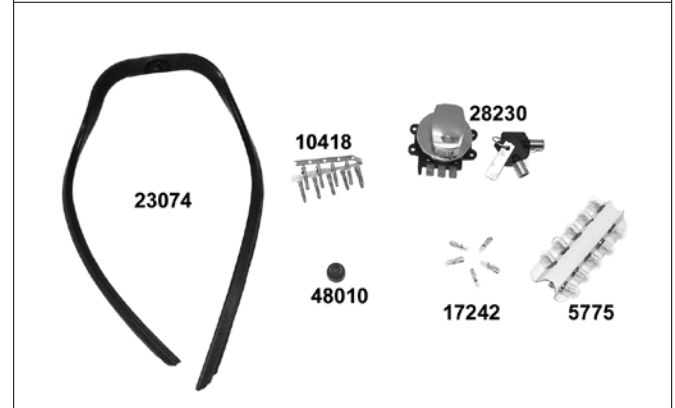

## FXST Bobbed Dash Components

- | PCP          | Description                                    |
|--------------|--|
| <b>45921</b> | 1996-99 Chrome dash panel w/switch             |
| <b>45922</b> | 2000-07 Chrome dash panel (71250-00)           |
| <b>5775</b>  | 1996-on Bulb, back light (53439-79)            |
| <b>62000</b> | 1996-on Bulb, back light (67136-85)            |
| <b>29727</b> | 1996-99 MPH Electronic speedometer (67027-96C) |
| <b>48566</b> | Preston, as above                              |
| <b>29730</b> | 2000-on Electronic speedometer (67033-99)      |
| <b>62008</b> | 1995-98 Speedometer lamp socket (67184-94)     |
| <b>73702</b> | 1996-98 Panel mount bracket(67260-96)          |
| <b>73703</b> | 1994-98 Speedo back clamp (67271-94)           |
| <b>73704</b> | 1994-98 Reset switch (67450-99)                |
| <b>48010</b> | 1994-on Reset switch boot (67880-94)           |
| <b>17242</b> | 1995-98 Indicator lamp bulbs (68024-94)        |
| <b>73705</b> | Dash lens (71146-94)                           |
| <b>23074</b> | 1996-on Panel trim (71265-95)                  |
| <b>73706</b> | 1994-on Switch name plate 1994-on (71302-93)   |
| <b>28230</b> | 1996-on Ignition switch (71313-96)             |
| <b>10434</b> | Plug, 3 way socket (72113-94BK) (pr)           |
| <b>10418</b> | Terminal, socket (72191-94)                    |
| <b>10435</b> | Socket lock (72153-94) (10pk)                  |
| <b>10436</b> | Connector, 12 place (73162-96BK) (5pk)         |
| <b>10437</b> | Socket contact (73191-96) (10pk)               |

# Big Twin Dash



## Speedo Light Socket

- 17412 FXR-SP/Con 1987-90 (67107-83)
- 17413 FXR, XL 1991-on (67107-91, 67202-86)
- 17414 Tach light socket FXR, XL 1983-86 (67034-83)



## FL Speedometer Light Sockets

- 3721 Plastic (71151-70) (each)



## Late Dash Plate Spacers

Used to space dash base to frame when lining up tanks.

- 11707 .030 (71027-68) (10 pack)
- 11708 .060 (71028-68) (10 pack)
- 11709 .120 (71029-68) (10 pack)



## FL Dash Lense Support 1968-95

- 48012 71134-68

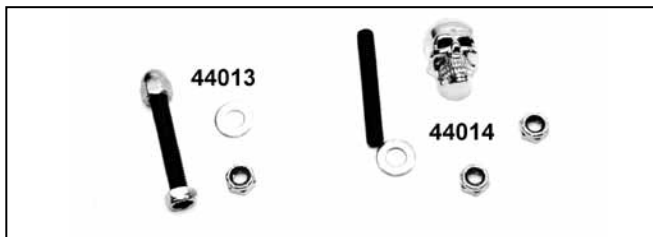

## Dash Mount Stud Kits

This little kit includes a stud, nuts, nylon washer and either a Skull or Acorn nut. It will fit 1968-on cast dash panel on FXST-FL-FXWG when choke cable is not used.

- 44013 Acorn style kit
- 44014 Skull style kit



## Small Dash Plug

- 1887 10 pack



## Console Nut

- | PCP   | Application   |
|-------|---|
| 62026 | 1990-95 and 2000-on Softail (not Duece, FXCW/C FLSTB, 2009 FLSTC), 1993-03 FXDWG, 1994-07 FLHR (94755-99) |

# Dash Trim & Covers



## Plain Chrome Dash

Chrome steel dash can be used on 2 or 3 light bases, when switch and indicator lights are not desired. Mount hole must be drilled. Great on the FXS conversion when switch is left in stock position.

**5796**



## Chrome Speedo Adaptor Ring

Adapts late model FX speedo into any FLH style dash cover. (FLH Dash shown with adaptor ring installed. Ring must be affixed with industrial adhesive for a leak proof seal.)

**5795**



## Dash Panel for Fat Bobs

Perfectly chromed and formed dash panel covers the gap between FatBob gas tanks.

**405** Plain



## Stock Tank Divider

Black rubber divider fits all Fat Bob tanks when seat "T" bar is used. Replaces OEM #61122-39.

**1361** Tank filler strip

**1362** Tank panel (not used with a 'T' bar)



## Chrome Louvered Dash Plates

Highly chromed steel dash plates with louvers are available to fit in the recessed area of all FXR dashes or 1968-92 Fat Bob gas tanks. To mount the FXR version, the stock dash must be drilled to mount the dash plate (hardware not included). The Fat Bob version has protective foam backing to protect the paint.

**PCP** Fits

**45028** 1968-92 FatBob cast dash

**45029** 1982-92 FXR

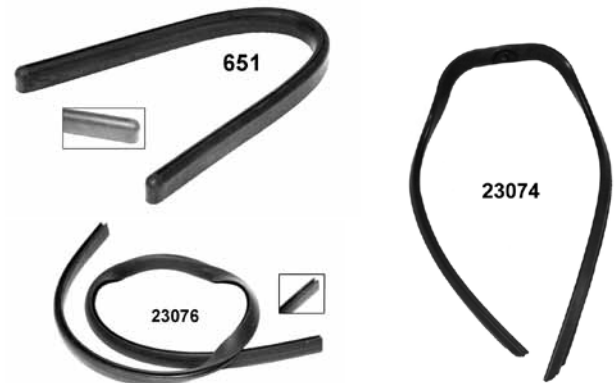

## Dash Board Rubber Strip

Closes the gap between dash and tanks. Helps prevent dash from wearing paint off tank and also reduces vibration. Black except where noted.

**PCP** Fits

**23100** 27" Chrome edge trim

**3732** FL dash 1968-on (71295-68)

**651** FXS dash 1977-on

**23074** FXST dash 1996-on

**23075** FLHR dash 1999-on (71001-94)

**23076** FXDL dash 1995-on (67119-95)



# Tank Dividers



## Chrome Dash for FXR

Chrome plated replacement dash fits all 1982-94 FXR models except FXRS 1988-on.

**2906\*** Replaces OEM 61411-82, 61412-82 & 61414-82

**\*Note:** Does not fit FXLR 1987-on or FXRS 1988-on when stock tanks are used.



## FXST Tank Panel

Black rubber divider on 1984-99 FXST.

**5452** 61155-84B



## Chrome Dash & Panel For 1988-92 FXRS and 1991-94 Dyna's except Wide Glides

PCP	Item
<b>45425</b>	Panel FXDL 1991-03 (61655-91)
<b>45420</b>	Panel FXRS 1988-92 (61635-88)
<b>45421</b>	Dash housing FXD, FXDL 1991-94, FXRS 1988-92 (67189-88)
<b>45850</b>	Dash FXDL 1995-03 (67189-95)
<b>23062</b>	Dash rubber trim (67119-85)
<b>23016</b>	Panel rubber trim(61648-85)



## Die Cast Tank Trim Panel

These diecast chrome dash panels fit FL, FXWG and FXST models 1968-99 with frame mounted seats. Available plain or with our new embossed "Eagle Spirit" emblem in chrome or gold over chrome versions. Replaces OEM 61118-81.

**2344** Plain chrome trim panel 1968-99

**45107** Chrome "Eagle Spirit" trim panel

**45207** Gold over chrome "Eagle Spirit" trim panel



## Chrome Dash Panel

Chrome dash panels replace the rubber unit found on Softail® models 1984-99 and FXWG models 1980-86. Attach easily with stock hardware. Available plain or with a highly detailed "Live to Ride" emblem in chrome. These dashes also work on earlier Big Twin custom applications with Fat Bob® tanks and single instrument diecast dash.

**45038** Plain chrome 1984-99

**45108** Chrome "Live to Ride"



# Dash Panel

29447



## T/L Leather Tanks Panel with Pouch

Black leather tank panel features a storage pouch with chrome concho and chrome angled stud pattern.

### PCP Application

29447 1984-99 Softail models (91177-97)

29443



## T/L Leather Tank Panel with Pouch

Stylish black leather tank panel features a storage pouch with decorative braided flap and concho.

### PCP Application

29443 1993-03 FXDWG and 2000-on Softail models except FXSTD, FXCW/C, FLSTB, FLSTFSE2, 2009-on FLSTC (91408-00)



## Dash Panel for Fat Bobs

Used on Fat Bob tank applications when dash or instruments are not mounted on tanks.

3138 Plain



## Tank Trim for FXS, FXEF

Chrome centre panel for the split tanks of 1977-85 FXS, FXSB, FXEF and FXB.

647 Plain

3286 Bracket set for above

29444



29445



## T/L Braided Leather Tank Panel with Pouch

Black leather panel with molded base features a decorative braided trim and a handy storage pouch with concho.

### PCP Application

29444 1984-99 Softail models (91026-94A)

29445 1993-03 FXDWG and 2000-on Softail models except FXSTD, FXCW/C, FLSTB, FLSTFSE2, 2009-on FLSTC (91409-00)

# Speedo Cable



## Barnett Speedo Cable Assemblies

All SS Barnett cables are clear coated.

### Application

40" FWD cable w/16mm top nut fits FXR, FLXR 1986-94, FXRS 1984-94, FXRS-SP/CON 1993-94, FXDS-CON 1994 and XL 883/1100 86-87

- 47280** Black
- 47285** Stainless

43" FWD cable w/16mm top nut fits XL 883/1200 1988-94, FXRS-SP, FXRS Convertible 87-92, FXE/FXRT 1983-85

- 47281** Black
- 47286** Stainless

47" FWD cable w/16mm top nut fits FXRT 1984, 1986-94, FXRD/FXWG 1986

- 47282** Black
- 47287** Stainless

40" FWD cable, 12mm top nut fits FLHT/C/C-U, FXST/S, FXDL, FXDC, FXDB, FXSTC 1984-94, FLTC 1980-86, FLTH 1980-86, FLHTC/P 1980-92, FXSTSB 1995, FXWG 1984-85, FXR, FXDB, FXDC, FXDWG 1992-94

- 47283** Black
- 47288** Stainless

35" FWD cable, 12mm top nut fits FLTC/-U, FLHS, FLST/C, FLSTF, Heritage Softail 1987-95

- 47284** Black
- 47289** Stainless

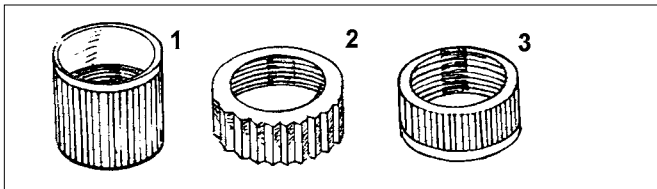

## Speedo Cable Nuts

For use with front wheel drive cables. Sold in 5 packs.

#	PCP	Description
1	12620	XL-FXR 12 mm
2	12621	FXE 1973-77, 16mm fine
3	12622	Fat Bob 16mm course 5/8" NPT

## Cable Adaptor

Allows the use of a 5/8" cable on 12mm threaded speedos.

**12631**

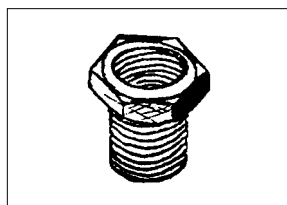

## Chrome Cable End Covers

These chrome accessories cover the fitting on speedo, tach and clutch cables. Sold each.

### Clutch Cable Cover

- 44020** Upper, all 1982-on
- 44021** Lower, XL 1986-on
- 44022** Lower, FXR 1987-94
- 44023** Lower, FXST, Dyna, FLT 1987-on

### Speedo/Tach Cable Cover

- 44024** Upper, 12mm cable nuts
- 44026** Lower, all front wheel drive speedo cable only

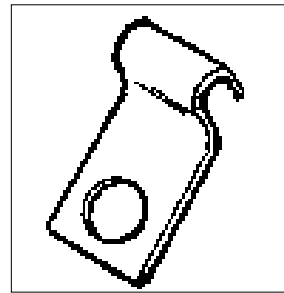

## Speedo Cable Mounting Clip

A stainless steel mounting clip used to retain the speedo cable when it runs between the transmission and a dash-mounted speedometer. It is retained by the case stud between the cylinders.

**9652** 1942-84 (67074-57A) (each)

# Speedo Cables

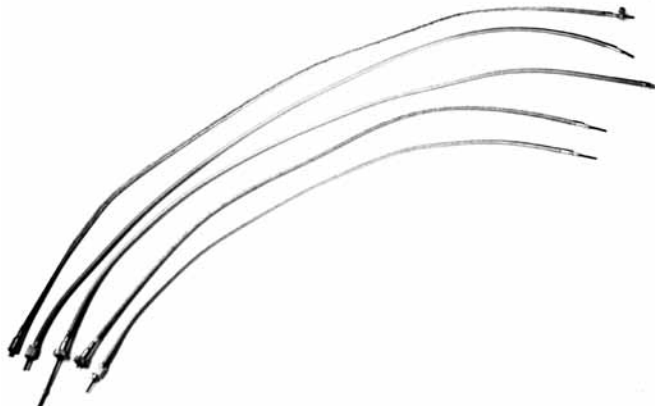

## S.S. Braided FWD Speedo Cables

PCP	Size	Fit
47616	46"	FXRT 1987-92
47609	43"	XLH 1988-94
47608	36"	FXE L 1984-87
47617	44"	FLHT 1980-92, FLT 1980-91
47619	34"	FLST 1987-95

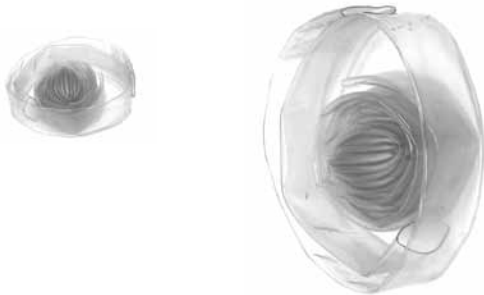

## Heat Shrink Tubing

Use clear heat shrink tubing on all braided stainless steel cables to help prevent scratching of chromed or painted surfaces. Kit contains 4-16" long heat shrink tubes to cover 2 throttle cables, 1 clutch and 1 speedo cable.

PCP	Application
28713	Cable sleeve kit
28714	3/8" x 10' roll
28715	1/2" x 10' roll
28716	3/4" x 10' roll

## Imported Cables

Black	S.S.	Description
<b>FL Models</b>		
2535	47600	1981-85 FLH-80, Classic (FWD) (67026-81)
4391		Same as above +4" (43")
4867		FLST 1987-on (67029-86A)
2538	47419	40" Fat Bob dash FWD, custom
4391		43" Fat Bob dash FWD, custom
47422		47" Fat Bob dash FWD, custom

## FLT Models

3645	47604	FLT 1979-85, FLTC 1986 (38") (67072-79)
3653		Same as above +4" (42")
3637		1986 FLHT (67060-79A)
3641		Same as above +4"
4868		1987-95 All FLT models (67060-87A)

## FXWG, FXST Models

4866		1984-on FXST, FXSTC (67024-84A)
3667	47601	1984-95 FXWG (67038-84)
3669		Same as above +4"

## FX Models

3629		1978-86 FX's, 1983-86 FXSB (67052-78B)
3633		Same as above +4"

## FXR Models

3629		1986-on FXR (67052-78B)
3633		Same as above +4"
4864		1985-FXRT, 1987-on FXRSE (67048-83A)
3657		1984 FXRT, 1986-on FXRT (67054-83A)
3661		Same as above +4"
4865		1986-on FXR, FXLR (67078-85A)

## XL Models

3629		1983-86 XLX, 1984-on XL (67052-78B)
3633		Same as above +4"
4864		1984-86 XLS (67048-83A)

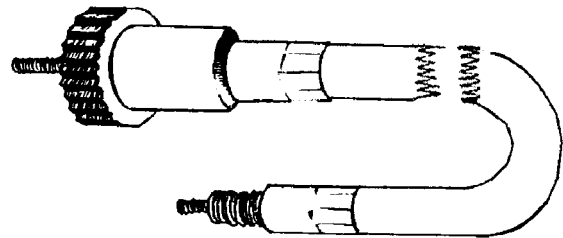

## Custom Front Wheel Speedo Cables

Front wheel drive speedometer cables that allow you to use any of our large FL style dash mounted 2:1 speedometers for front wheel speed drives. Cable has two speedo head nuts to cover most models. Also replaces the stock cable on 1984 FXWG or FXST. The ideal cable for installation with our FXR FatBob tank 6478.

2538	40" long
47419	As above, stainless
4391	43" long
47424	As above, stainless
47422	47" long

# Speedo Drives



## Front Wheel Speedometer Drive Units

### PCP Fits

- 3722** 1984-94 19" Wheels, all 1983-on FX-FXR, 1984-94 FXDL XL (67127-84A)
- 2542** 1984-95 FXST & FXWG w/ 21" wheels (67120-84B)
- 2547** 1982-86 FLT (67073-81)
- 4071** 1987-98 FLT, FLHT, FLHS (not FLHR) (67073-87A)
- 4072** 1987-94 FXLR (67132-85A)
- 4073** 1986-95 FLST, FatBoy & Nostalgia (67125-86A)
- 4074** 1988-95 FXSTS (67166-88)



## TopLine Pre-Digital Speedometer Drives

- 29701** 1982-86 FLT (67073-81)
- 29702** 1987-98 FLT, FLHT, FLHS (not FLHR) (67073-87A)
- 29703** 1984-95 FXST & FXWG w/ 21" wheels (67120-84B)
- 29705** 1986-on FLST, FatBoy, Nostalgia 87-95 (67125-86A)
- 29707** 1984-94 All FX's-FXR 1983-on, FXDL 1991-94 XL 1984-95 with 19" wheels (67127-84A)
- 29708** 1987-93 FXLR (67132-85A)
- 29709** 1988-95 FXSTS (67166-88)



## Chrome Speedo Drive Covers

- These covers fit perfectly over the stock speedo drive unit.
- 45315** FXST-FLST and 4-speed FXWG 1984-95 as well as all FLT, FLHT and FLHS models 1987-on, Dyna Wide Glide 1993-on (left side)
  - 45316** All Sportster®, FX, FXR and Dyna Glide® (narrow) models with 35mm or 39mm front forks 1984-on (left side)
  - 45317** FLT 1982-86 (R/S)



## Speedometer Cable Rubber Boot

- Fits all models with front wheel drive on 1973-on.
- 5443** 94996-85 (5 pack)



## Chrome Speedo Drive Cover

- Chrome, one-piece design provides an attractive cover for the rubber speedo cable boot and drive. Fits FXST, FXWG 1984-95 and FLHT, FLHS 1987-on.
- 45303**



## S&S Speedometer Calibrator

- Fits all BT and XL models equipped with OEM electronic speedometer. Allows precise adjustments in 1% increments between -29% and +69%. Compact size for easy installation. Sensitive components are sealed in epoxy for protection from vibration and weather.
- 551007**